

It's Sew Easy Series 2100 – It really is SO Easy!

Show#2101-1 Serge It or Sew It

Presented by: Joanne Banko

www.letsgo sew.com

Let's stay in touch! I'd love to help you make the most of **your** sewing machine!

[CLICK HERE](#) to add your name to the letsgo sew.com email list and receive timely tips, sewing news, free tutorials, and special updates. You'll be the first to know about new blog posts and detailed previews of the online It's Sew Easy TV show.



Sew it or serge it? That's the question! In this show we'll explore seam finishes, hemming, and gathering on both the serger AND the sewing machine. We'll compare the results of each technique stitched on the sewing machine and sewn with a serger. Samples help you see when to stitch on your sewing machine and when to head to the serger.

Are you ready? Let's go sew!

Machines and supplies featured or recommended in this show:

- [Brother](#) Pacesetter PS5234 Serger
- [Brother](#) Stellaire combination sewing and embroidery machine
- [Brother](#) Sewing and Serging Accessories:
 - Overcasting foot "G" for sewing machine
 - Blind hem foot "R" for sewing machine or [SA133](#) adjustable blind hem foot
 - Blindhem foot for serger

Fig.1

Tips for overcasting woven fabric on the sewing machine:

The sewing machine has lots of different overcast stitches to choose from. Check the feet that came with your machine for a special overcasting foot. Using an overcasting foot makes a big difference. It has a pin along the edge that is similar to the stitch finger on the serger. I used foot **G** on the Brother machine, along with one of my favorite basic overcasting stitches. See **Figure #1**.

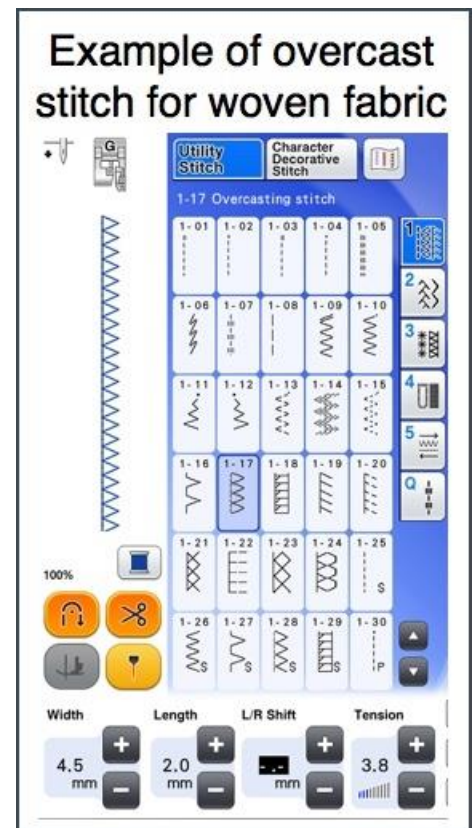

Tips for overcasting woven fabric on the serger:

When serging to clean finish or overcast raw edges, the serger keeps the fabric really smooth and has the advantage of trimming excess seam allowance or frayed edges at the same time that the edge is finished.

Fig.2

For the most coverage on average woven fabrics, set up the serger for a three-thread wide stitch, removing the right needle. Check your manual for details. See **Figure #2**.

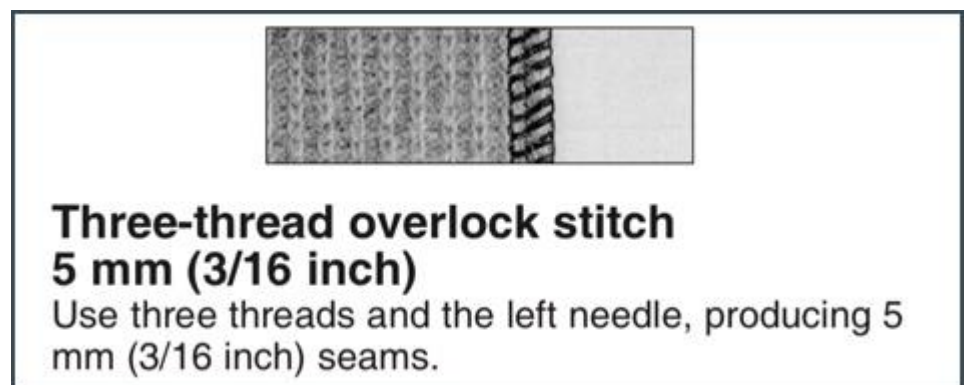
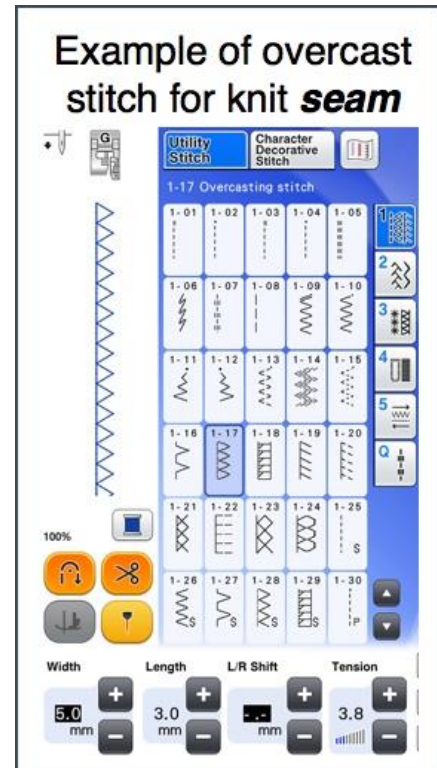

Fig. 3



Tips for stitching a knit seam on the sewing machine:

On the sewing machine, I used foot **G** for the knit seam. Modify the stitch with a wider width and lightly longer length to sew the seam and overcast the edges at the same time. See **Figure #3**.

Tips for stitching a knit seam on the serger:

The three-thread wide stitch is also ideal for a knit seam on the serger. If the seam gets wavy you can use a positive differential feed setting to keep it smooth. The serger produces a super stretchy seam and once again, you can trim excess fabric as you stitch.

Extra Tip: Knits and other fabrics may require adjustments for the cutting width on the serger or other changes to settings. Always make a sample and adjust in small amounts until you like the look of the stitch. **Figure #4** shows a special attachment for fine tuning the stitch on the featured Brother serger. Check your manual for more details.

Fig. 4

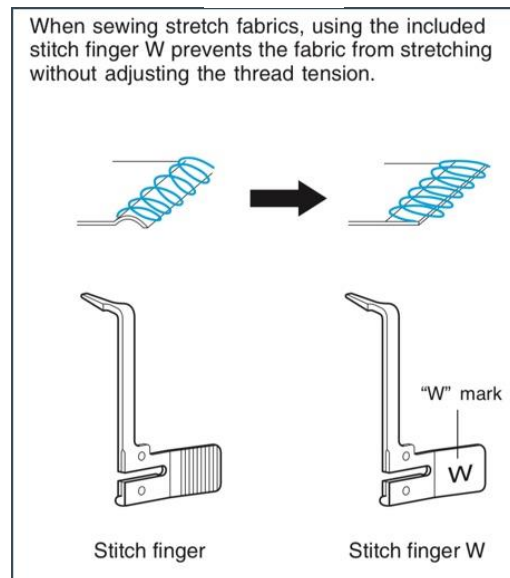

Fig. 5

Tips for sewing a blind hem on the sewing machine:

The preferred foot for a blind hem on the sewing machine has a guide that helps you sew along the folded portion of the hem. The Brother machine comes with foot "R" for blind hemming. You'll find two blind hem stitches side by side in the menu. The standard blind hem stitch travels along the hem allowance with a straight stitch. The stretch blind hem stitch travels along the hem allowance with a slight zig zag to allow for stretch on fabrics with give. See **Figure #5**.

Depending on the fabric, you can adjust the stitch settings, so the "bite" of the blind hem stitch is hidden in the fabric, making it truly a blind hem.

For fabrics that ravel you'll need to clean finish the raw edge of the hem with binding, seam tape, or an overcast stitch before you sew the hem.

Note: An adjustable blind hem foot is another option for blind hemming.

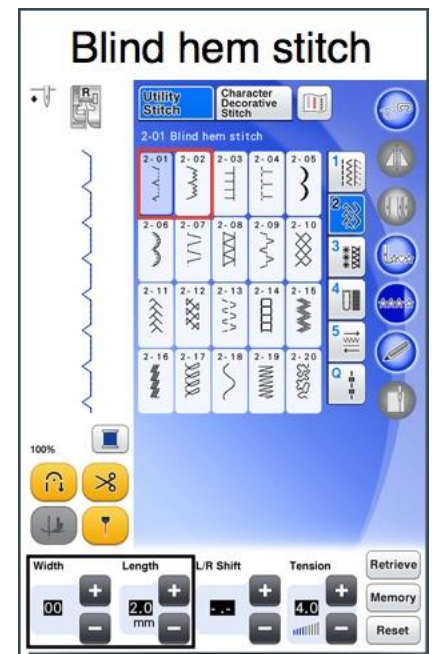
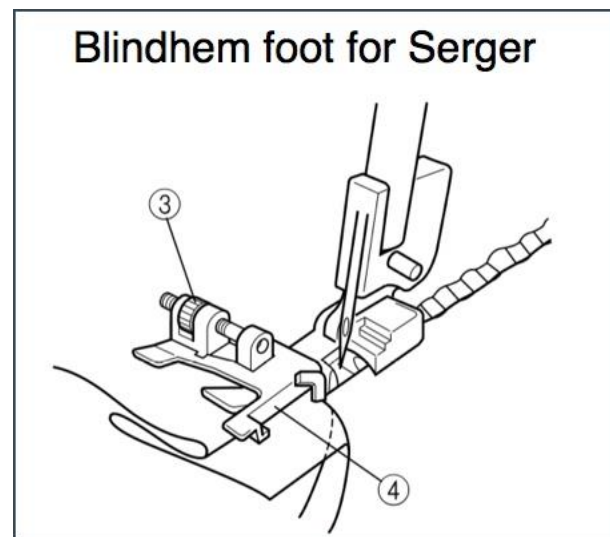

Fig. 6

Tips for sewing a blind hem on the serger: There is an adjustable blind hem foot for the serger as well. See **Figure #6**. When stitching the blind hem on a serger you'll achieve the best results with the following settings: Use a three-thread wide stitch with a long stitch length, loose needle tension, slightly tightened upper looper tension, and slightly looser lower looper tension. These settings are used to form what is commonly called a flatlock stitch. A flatlock stitch allows you to press the hem very flat.



When using the serger for blind hemming, you will always see some of the stitching because stitches form very close together. The serger blind hem works especially well for knit fabrics. With matching thread, the stitches tend to show much less on knits than on woven fabrics. However, an added advantage on woven fabrics is the fact that the raw edge is finished at the same time the hem is stitched. See examples of serger blind hemming on a knit below:



Tips for gathering on the serger:

Basic machine set up for the maximum amount of gathers is as follows: Begin with a three or four thread balanced stitch. Set differential feed to highest positive setting, set stitch length for as long as possible, and tighten the needle tension to near maximum. Trim as you go or serge right along the raw edge. Be sure to leave long thread tails if you need to ease the gathers off after stitching. **Extra Tip:** Keep your finger behind the fabric as it exits behind the presser foot to push in extra gathers as you stitch. Use this technique on a single or double layer of lightweight fabric. **Note:** Easing off on any of the three suggested settings, (1) high differential feed number, (2) long stitch length, and (3) tight needle tension, will lessen gathers. I usually opt for more rather than less gathers, and ease off the gathers as needed.

Fig. 6

Tips for gathering on the sewing machine:

There are many ways to gather on a sewing machine. Sewing a basting length stitch and pulling up the bobbin thread is one common method. I used a special basting stitch where the length can be adjusted, and the tension is automatically loosened. Loose tension makes it easy to pull the thread to gather. Set stitch length between 5 to 10 mm. See **Figure #7**. Stitching two to three rows of basting is preferred but for speed I chose to sew only one row.

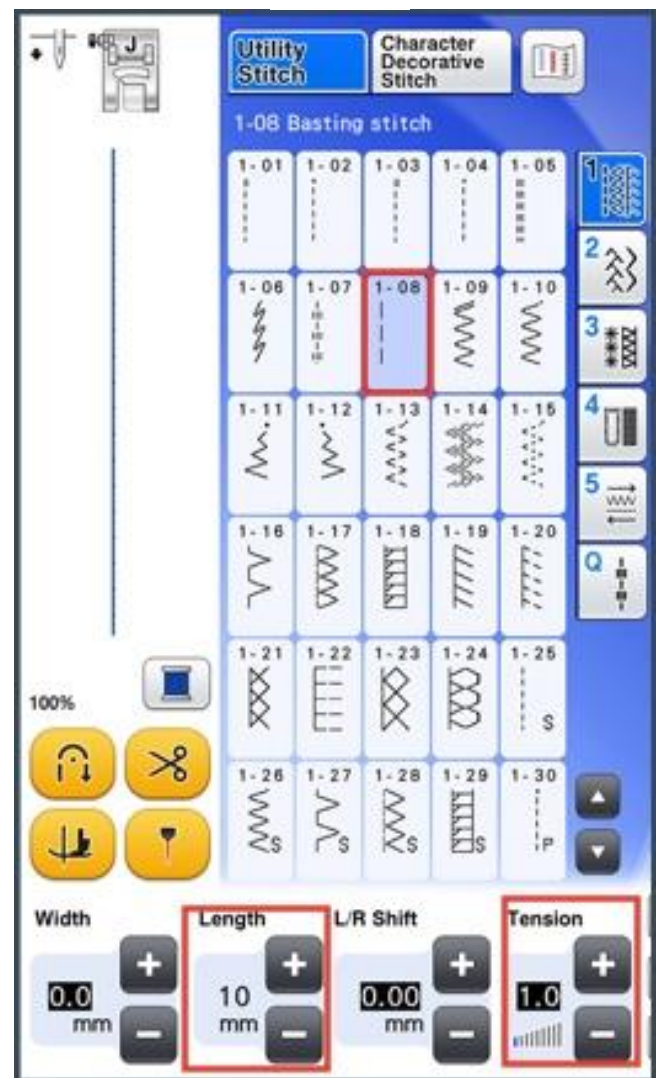

This show includes just a sampling of various options and techniques for sewing versus serging! I plan to cover many more in the days ahead. I invite you to [CLICK HERE](#) to review instructions from It's Sew Easy TV show 1505-2, Machine Wizardry for more utility stitch demonstrations on the sewing machine. You'll also find a post about blind hemming with the stretch blind hem stitch when you [CLICK HERE](#).



Additional Resources:

- For more projects and tutorials, be sure to visit www.letsgo sew.com. You'll find online lessons, videos, free downloads, plus lots of sewing and embroidery information and inspiration!
- [CLICK HERE](#) to sign-up for sewing news from letsgo sew.com.
- [Subscribe to my YouTube channel](#) for Let's Go Sew videos.
- You can find me on Facebook [HERE](#).

Happy Sewing!

A handwritten signature in cursive that reads "Joanne". The letter "J" is written in red, while the rest of the name is in black.